

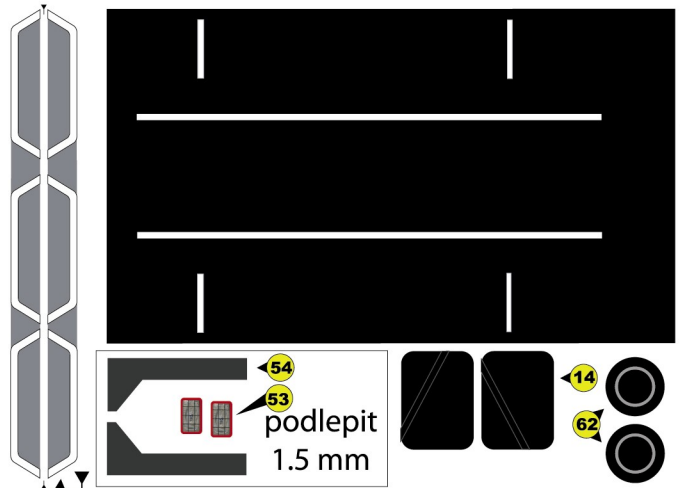

# BABČA

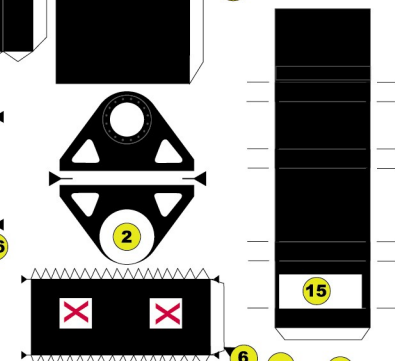

54  
53  
podlepit  
1.5 mm

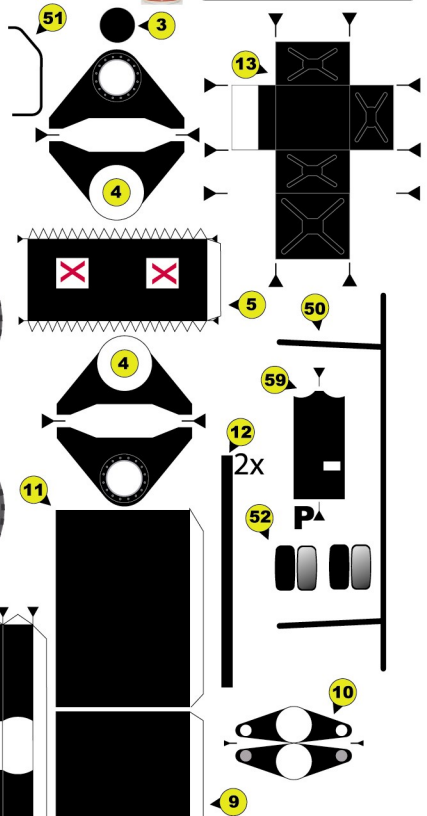
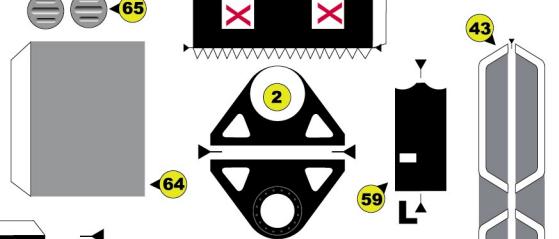
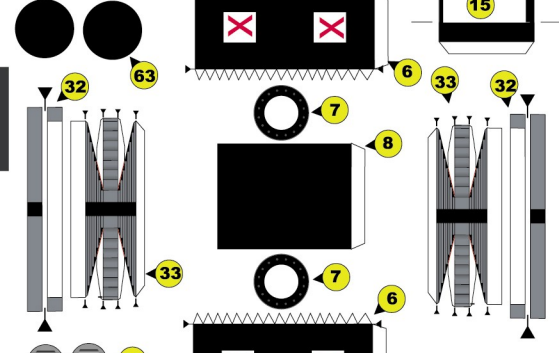
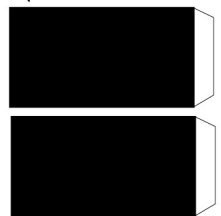
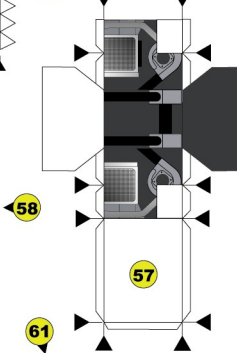
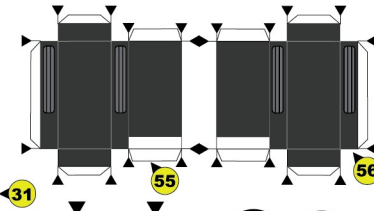
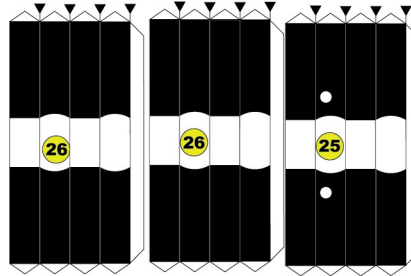
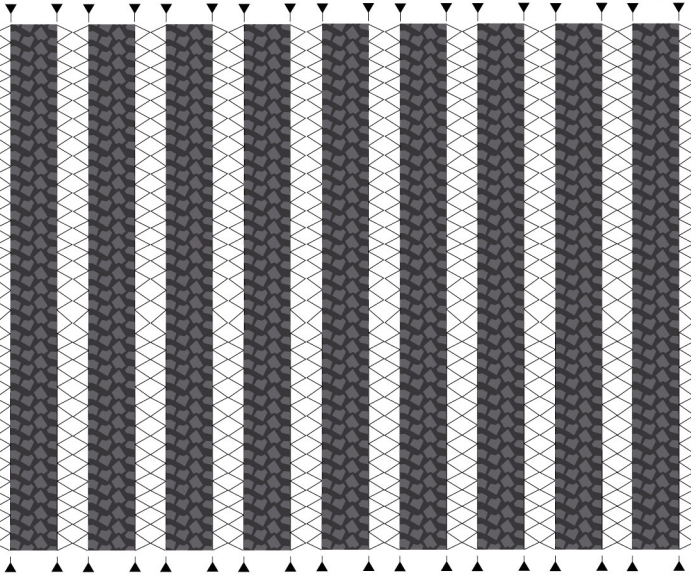
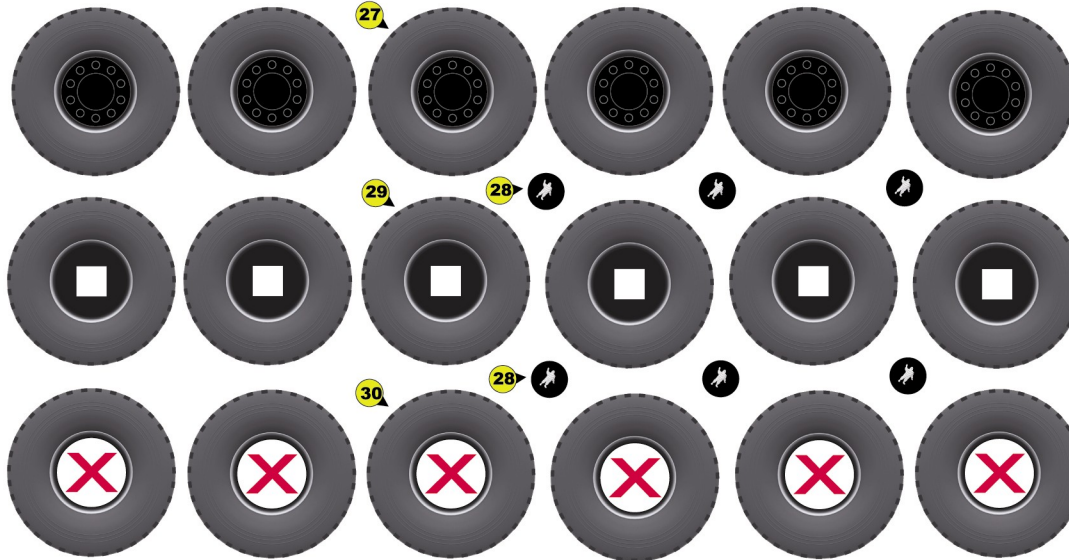
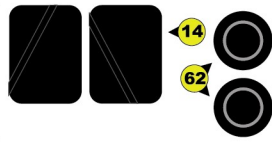

Design and illustration : Roman Hruška 2007  
e-mail: hruska.romi@seznam.cz  
ICQ: 290-690-816  
<http://papirove-tatry-z-dakarui.cz/>



Design and illustration : Roman Hruška 2007  
e-mail: hruska.romi@seznam.cz  
ICQ: 290-690-616  
<http://papirove-tatry-z-dakaru.ic.cz/>





# BABČA

